

### GENERAL NOTE

- DETAILS ARE SUBJECT TO CHANGE WITHOUT NOTICE.
- DIMENSIONS WILL NOT SHOW ON THESE FILES.
- PLEASE ADD THEM O YOUR DRAWING ACCORDINGLY.

### LÉGENDE

: NAME FOR AUTOCAD FILES

## HEAD AND JAMB SECTIONS

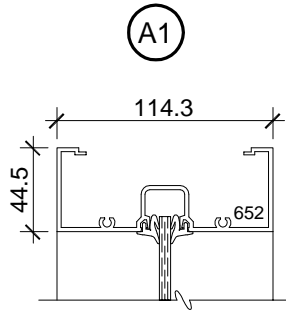

**652**  
file 652ST

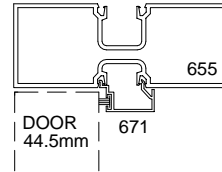

**655**  
file 655U1T

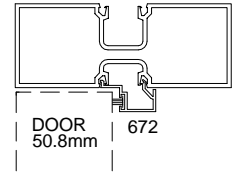

**655**  
file 655U2T

## SILL SECTION

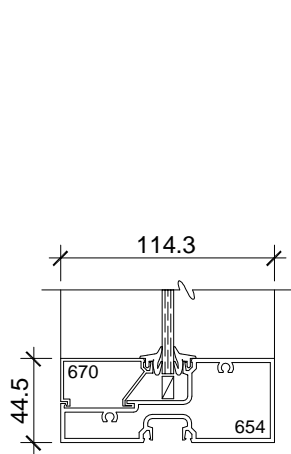

**654-670**  
file 654SB

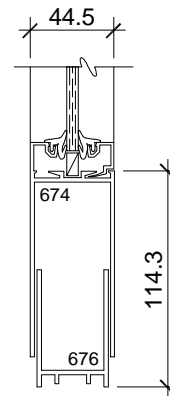

**674-676**  
file 674SB

## HORIZONTAL MULLION SECTIONS

C1

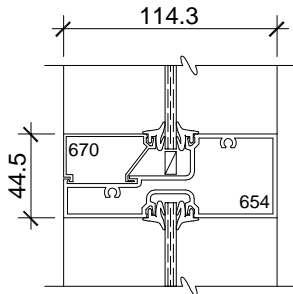

**654**  
file 654SS

C2

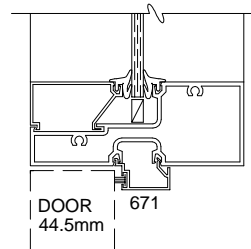

**654**  
file 654SU1

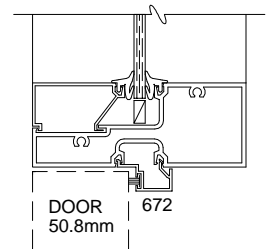

**654**  
file 654SU2

## VERTICAL MULLION SECTION

D1

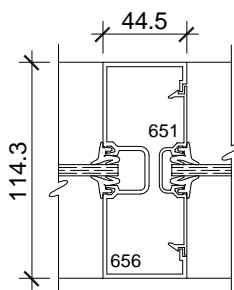

**656**  
file 656SSH

D2

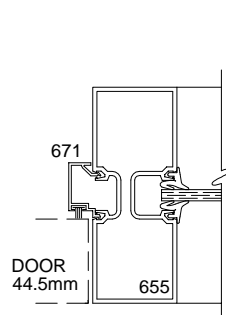

**655**  
file 655U1SH

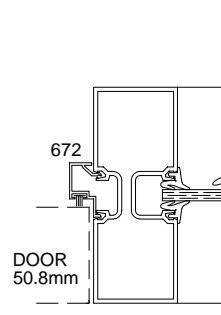

**655**  
file 655U2SH

D3

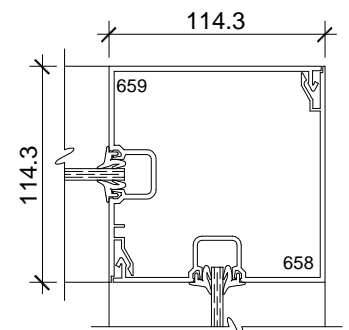

**658-659**  
file 658SSQ